

DMTech Ltd. Pleven

REPEATER

FP 9000R



Installation, setup and operation.

Rev 02:17

RS485

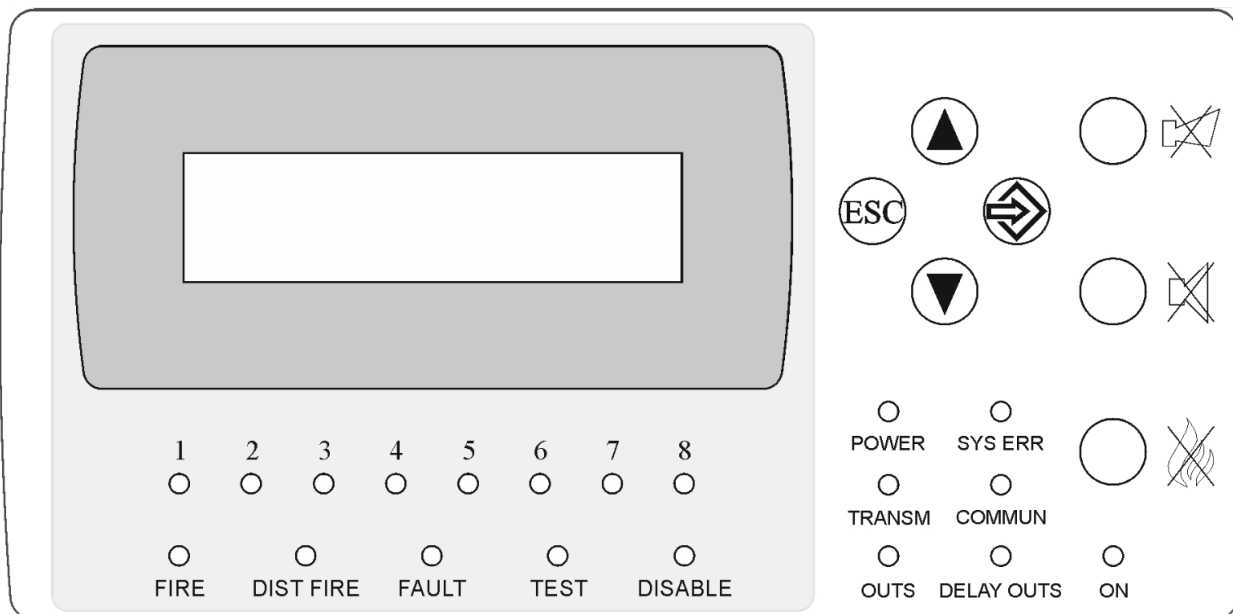
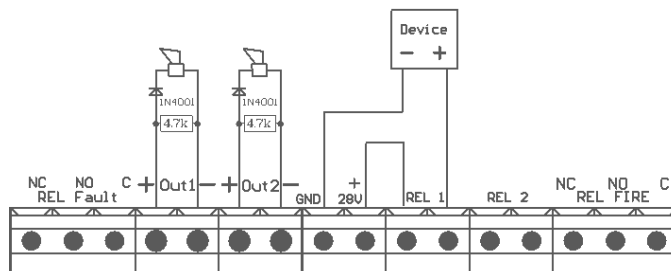

P. CONTENTS:

- 2 INTRODUCTION
- 2 TECHNICAL PARAMETERS
- 5 CONTROLS AND INDICATION
- 6 FACTORY SET PARAMETERS
- 7 INSTALLATION AND PANEL SETUP
- 14 ACCESS LEVELS
- 16 PANEL CONDITIONS
- 20 CONDITIONS FOR USE, STORAGE AND TRANSPORT
- 21 CONTENT AND COMPLEX OF DELIVERY
- 21 WARRANTY

1. INTRODUCTION

FP9000R is a repeater for conventional Fire alarm panel FP9000 2/4 and FP9000L 2/4/6/8. Through the display and keyboard can be programmed and adjusted over 70 functional parameters. Each remote panel has 7 individual programmable parameters. With its 6 outputs, including 4 programmable, giving flexibility and adaptation to new and existing installations. All the panel conditions information is displayed on LCD 2x16 display and LED indicators. Volatile memory and real time clock enable recording and review of 1200 archive events.

Quick and easy - installation, setup and starting. Simple and clear procedures for operation and maintenance of the system.

2. TECHNICAL PARAMETERS

<u>LINES</u>		
➤ Lines:		
• Number of fire panels in networking	1 to 8	Optional
• Type of the joining line	biconductional	
• Maximum length of wires	1200 m / 0.75mm²	
<u>OUTPUTS</u>		
➤ Independent relay output in case of fire alarm:		
• Quantity	1	
• Type	switching	NC / NO
• Electrical characteristics	3A/125V AC, 3A/30V DC	
➤ Controllable output in case of fire alarm:		
• Quantity	2	programmable
• Type	potential relay	
• Electrical characteristics	(19-28)VDC/ 0,5A	
➤ Relay output in case of fire alarm:		
• Quantity	2	programmable
• Type	potential-free	NO
• Electrical characteristics	3A/125V AC, 3A/30V DC	
➤ Additional relay outputs (modul M9000R 2/4/6/8) in case of fire alarm:		
• Quantity	2/4/6/8	programmable
• Type	potential-free	NO
• Electrical characteristics	3A/125V AC, 3A/30V DC	
➤ Independent relay output in case of failure:		
• Quantity	1	
• Type	potential-free, switching	NC / NO
• Electrical characteristics	3A/125V AC, 3A/30V DC	
<u>POWER SUPPLY</u>		

➤ Mains power		
• Voltage	(187-252)V AC	
• Frequency	50/60 Hz	
• Maximum power to mains power	65W / AC	
➤ Battery power		
• Battery quantity	2	
• Type of the battery	Lead, gel	
• Battery rated voltage	12V DC	
• Reted power C20	5 Ah	
• Charger voltage	27,6 VDC	temperature compensated
Consumption of battery power in standby mode		
• battery power	< 50 mA to 24 VDC	
Time needed in security mode when mains power supply is down with battery 12V/ 5Ah		
•	100h	
Executive devicess powering		
• Voltage	(19-28)V DC	
• Maximal current (including the controllable outputs current)	2A	
Fuses		
• Mains power 230V AC	4,0 A fusible	
• Battery power	6,3 A fusible	
• Powering external devices	1,85 A automatic	
• Controllable outputs	1,1 A automatic	
Functional characteristics		
• Control controllable outputs for fault conditions (short circuit and interruption) and automatic reset;		
• Control of the remote panels and automatic reset;		
• Light and textual indication for Fire, Fault, Disable and Test mode;		
• Ability to delay controllable and general outputs for fire for a period of 10 to 600 seconds after the registration of state Fire;		
• Built-in sounder in case of fire – monotonal, continuous with the possibility of exclusion;		
• Ability to Disable controllable outputs for fire;		
• Interface for communication with external devices RS485 and networking;		
• LCD display, 2×16 characters and keyboard, for control and panel indication;		
• Energy independent archive of the events, recorded by the panel, consisting of type, date and time of the event - to 1600 events;		
• Choice of language for text information display;		
• A set of test modes and options for adjustment of lines, outputs and panel.		
➤ Over all size	310x240x80 mm	
➤ Weight without batteries	1,3 kg	
➤ Safety degree	IP30/ EN 60529	
The panel meets standards:		
• EN 54-2:1997		







• EN 54-2:1997/A1:2006
• EN 54-2:1997/AC:1999
• EN 54-4:1997
• EN 54-4:1997/A1:2002
• EN 54-4:1997/A2:2006
• EN 54-4:1997AC:1999
• EN 50130-4:2011
• EN 55022:2006/A1:2007
• EN 60950-1:2006/A11:2009

3. CONTROLS AND INDICATION

➤ LED indicators

Indicators	Function
“POWER”	Constant green light
“FIRE”	Common indicator - flashing or constant red light in Fire condition
“FAULT”	A common failure indicator. Upon failure of any type a yellow light will start flashing
“SYS FAULT”	A system failure due to stoppage of the CPU. A constant yellow light will light up. Needs to be repaired at an authorized service.
“POWER FAULT”	In case of fault or loss of an AC or battery power supply a steady yellow light will light up.
“TEST”	When in line test condition a constant yellow light will light up.
“DISABLE”	When in Disabled component / line or controllable output / a steady yellow light will light up.
“OUTS”	Illuminates with steady yellow light at short or interruption of output devices power supply line
“DEL OUTS”	Continuous yellow light at preset delay of connected outputs
“BUZZER SILENCE”	Indicator to the button "BUZZER SILENCE", in suppressing local telltale, a steady red light will light up.
“SOUND SILENCE”	Indicator to the button "SOUND SILENCE", when suppressing Fire outputs, a steady red light will light up.
“COMUN”	When of the for data transmission device failure by RS485, a constant yellow light will light up.
“TRANSM”	In case of device failure, will transmit a Fire alert to a remote center.
“1 2 3 4 5 6 7 8”	Individual indicators for Fire and line failure in Remote fire panels- Fire is lit with red light, fault lights up with yellow light. When disabled and line test there is an indication of the respective condition.

➤ **BUTTONS**

Button	Panel condition	Access level	Действие на органа за управление
“RESET” 	Fire	Level 2	Exit from Fire condition.
“SOUND SILENCE” 	Fire	Level 2	Where activated outputs for Fire - silence of the same outputs.
“BUZZER SILENCE” 	Fire и Failure	All Levels	Suppression / activation of the local sounder
	Fire, Failure, Test and Disable component	Levels 1 and 2	Entry in Information and management condition.
	Information and management	Levels 1 and 2	- Displaying the next element onto the display; - Moving of the cursor; - Modification of the selected parameter.
	Fire	Levels 1 and 2	- Displaying the previous text message for Fire onto the display.
	Information and management	Level 1 and 2	- Displaying the previous element onto the display;
	Options	Level 3	- Modification of the selected parameter.
	Fire	Levels 1 and 2	Displaying the next message for Fire onto the display
	Information and management	Levels 1 and 2	- Displaying the next element from the menu onto the display; - Moving of the cursor;
	Options	Level 3	- Modification of the selected parameter.
	Information and management	Levels 1 and 2	- Exiting a function without saving changes in parameter -no command execution; - Exiting from the current menu and transition to the upper menu in the hierarchy.

4. DEFAULT PARAMETERS

The repeater panel provides users with default parameters, described in the table below. These parameters are saved and recorded from menu "Default par."

<u>INPUT LINES</u>		
➤ Remote panels:		
• Quantity	1	Enable
<u>OUTPUTS</u>		
➤ Independent relay output in case of fire alarm:		
• Quantity	1	EN 54-2, independent
➤ Programmable controllable output in case of fire alarm:		
• Quantity	2	Not connected to zones
➤ Programmable relay output when fire alarm:		
• Quantity	2	Not connected to zones
➤ Independent relay output during failure:		
• Quantity	1	EN 54-2, independent
Functional characteristics		
• Controllable and general outputs delay in case of fire. (The delay is valid only when outputs are connected to zones)	60 seconds	

FUNCTION

Repeater FP9000R:

- receives data for Fire condition from the remote fire control panels;
- receives data for Fault condition from the remote fire control panels;
- displays information for the condition of remote fire control panels;
- executes control commands to lines of remote fire control panels for their forced exit of Fire condition;

Repeater FP9000R could be used:

- when the persons whom are expected to detect and react initially to the fire condition and/or fault condition signals are at a different place from the location of the fire control panel/s;
- when fire control panels located at different sites have to be monitored and controlled from one place;
- when the fire control panel/s are monitored from several locations.

5. REPEATER INSTALATION AND SETUP

5.1 Panel assembly.

- Unpack the repeater;
- Mount the dowels at the appointed place for fixing the repeater;
- Attach the repeater to the dowels through the three holes on the chassis

It is recommended that the panel should not be installed near heat sources (radiators, air conditioners, etc.).

- The connecting wires are mounted, using the hole in the box.

5.2. Connecting remote panels.

- The repeater may be connected to eight fire panel.
- The connection between the devices along RS485 is executed by parallel connection along the two-wire line as it should be observed potential “A” and “B” not to be crossed. The maximal distance between the final point devices is 1200 meters.

The recommended connecting wire cross section should not be less than:

- Up to 1200 m - connecting wire 2 x 1.0 mm²

In the case of long distances or environment with electromagnetic radiation it is recommended the wire to be double-core or shielded. If the wire is shielded, the shield should be connected only in one end to “earth” terminal on the respective fire control panel or repeater.

Regardless the line length a jumper should be installed to the first and the last device to terminate the line by 120 ohms. The jumper should be removed from all other devices.

The setting MASTER of the repeater and the fire control panels connected to it does not depend on the physical location of the devices in the network. The repeater could be physically connected anywhere in the line. If it is the first or the last device (in RS485 there is only one two-wire line connected), it should be terminated with the jumper. The same rule applies for the fire control panels too.

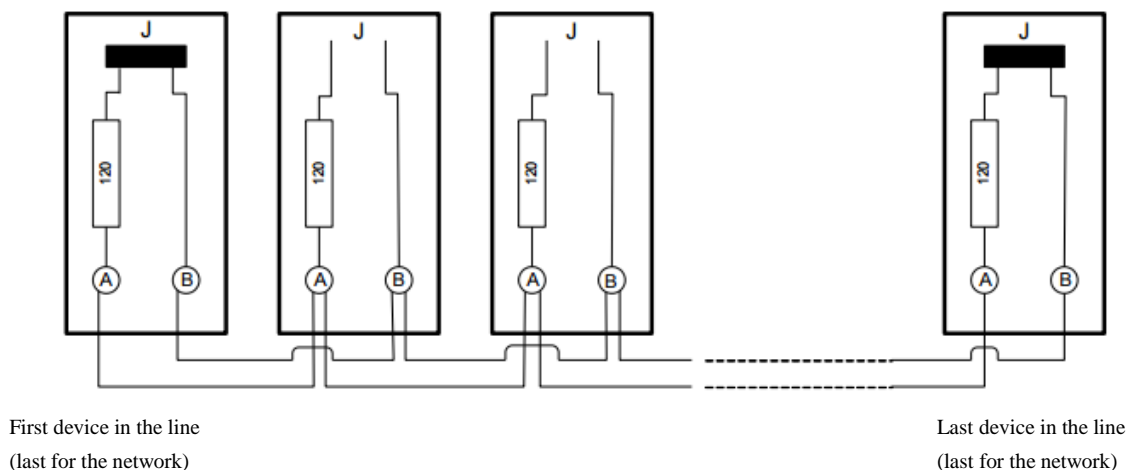

- Connection to FP9000L 2/4/6/8 fire control panel In order to operate in a network FP9000L fire control panel has to be completed with an extended module M9000-485 is located. In the fire control panel it is fixed:

- network address – corresponds to the fire control panel serial number;
- data exchange rate– 9600 Bits/s.

- Connection to FP9000 4/8 fire control panel In order to operate in a network FP9000 fire control panel has to be completed with an extended module M9000-485 is located. Network address is set from the menu panel FP9000.

- data exchange rate– 9600 Bits/s.

- Checking the line resistance

With switched off power supply of all connected objects, the line resistance is measured by means of an electronic measuring instrument:

- If the measured resistance is in the range 45Ω to 60 Ω - the line is within the referent values;
- If the measured resistance is < 45 Ω - there are more than two installed terminating resistors in the line;

- If the measured resistance is $> 60 \Omega$ - both ends of the line are not terminated by resistance of 120Ω .

- **Outputs**

To each line can be joined 4 programmable outputs, that will be activated when Fire condition of the respective line. The panel has two controllable potential relay outputs and two potential-free relay. The factory setting is without the connected outputs. Depending on the project and the type of object, join the necessary outputs.

- **Delay Outputs**

For each line has the ability to set a delay to trigger the outputs, that are connected to it. It is possible of a delay of 0 to 600 seconds. The election takes place every 10 seconds. If it is 0 we have direct actuation. The factory setting for all lines is 60 seconds. The delay is only active when there are connected programmable outputs. The function allows for each guarded line to determine individual time for a physical check to the secured area for authentication alarm. The aim is for the time to be enough to check the area and return to the panel for a possible reset to Fire condition and in case of spurious actuation, to prevent inclusion of sirens and executive devices.

Example:

If you have an object of 4 floors with panel located on the first floor, it can be given for example the following location and time parameters:

1 and 2 line guard the 1st floor - time to view 80 sec.

2 and 3 line guard the 2nd floor - time to view 120 sec.

4 and 5 line guard the 3rd floor - time to view 170 sec.

6 and 7 line guard the 4th floor - time to view 240 sec

5.3. Installation of the executive devices at panel

All connections are made by means of terminals, mounted on the printed circuit board (Fig.4).

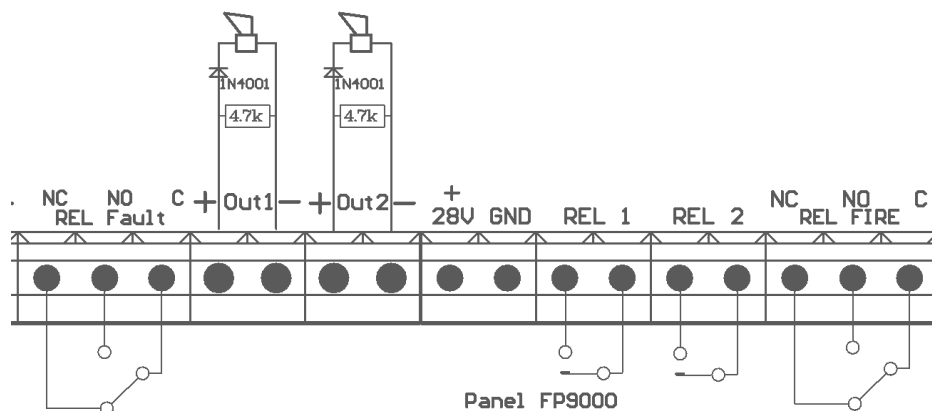

Fig. 4

Total consumption of the voltage powering the external devices (terminal "+28 VDC") and the consumption of the controllable outputs shall not exceed 2,0 A in the heaviest mode.

5.3.1. Installation of the executive devices to the panel's controllable outputs.

Terminals "+ Out x", "-Out x" - controllable, potential outputs, responding at Fire condition, are used. At the end of the line a resistor 4,7k/0.25W (from the design of the panel) is mounted. It is

recommended that in series with the power supply of the corresponding device to place a diode (Fig.5). We recommend 1N4001 diode or equivalent. The panel constantly monitors for failure (interruption or short circuit) power line devices.

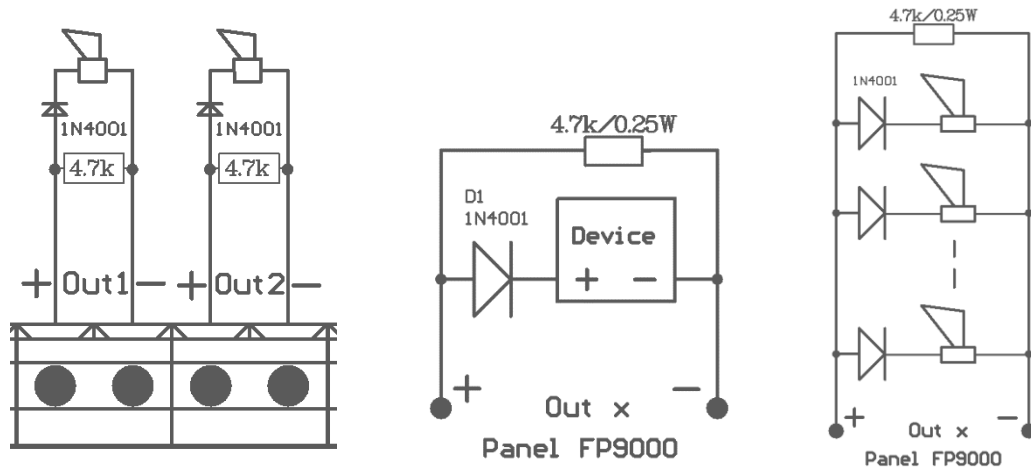

Fig. 5

If controllable outputs are not used, directly to terminals "+Outx", "-Outx" a resistor 4,7k/0,25W is connected, otherwise the outputs will be in Fault condition.

5.3.2. Installation of the executive devices to RELAY OUTPUTS.

Used:

- Terminal "+28VDC" - positive lead of the stabilized direct voltage for external devices (light and sound signaling devices, executive devices, etc.);
 - Terminal "GND" – (negative lead for supplying the external devices);
 - Terminal of the corresponding relay outputs.
- Relay outputs with changeover contacts for **Fault (REL Fault)** and **Fire (REL Fire)** conditions.
- When in Fault condition of the panel, output - **REL Fault**, is activated immediately, regardless of the type of fault. The output may not be disabled or delayed.
 - Upon entering the panel's condition **Fire**, no matter what line, output - **REL FIRE** be activated immediately. The output may not be disabled or delayed.

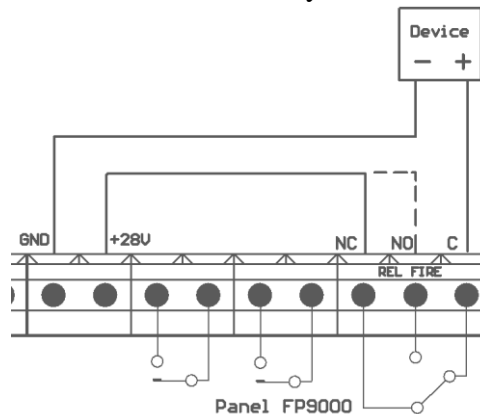

Fig. 6

- **REL Fault** - terminals "REL Fault/C", "REL Fault/NO" and "REL Fault/NC" - potential free relay contacts of the relay. In the absence of failure, there is a link between terminals "REL

- Fault/C" and "REL Fault/NO", and in case of failure - between terminals "REL Fault/C" and "REL Fault/NC".
 - **REL FIRE** - terminals "REL FIRE/C", "REL FIRE/NO" and "REL FIRE/NC" - potential free relay contacts of the relay. In standby mode there is a connection between terminals "REL FIRE/C" and "REL FIRE/NC " and in case of Fire - between terminals "REL FIRE/C" and "REL FIRE/NO ".
- Programmable relay outputs in **Fire (REL 1)** and **(REL 2)**.
 The terminals of the relay outputs are - potential free relay contacts of the relay. In standby mode there is no connection between terminals, but when joining the output to line and Fire condition in the same line, a connection is made by the relay contacts, which are displayed on terminals.

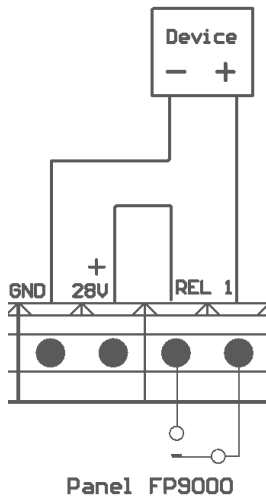

Fig. 7

- **Fire alarm lines' function "AND"** scheme with using relay outputs (REL 1) and (REL 2).
 If the panel is used to control the **putting out** or other automatic devices requiring high security in case of Fire alarm, it is recommended to realize the 2 Fire alarm lines' function "AND" (only two lines in Fire activates output). Used following scheme:

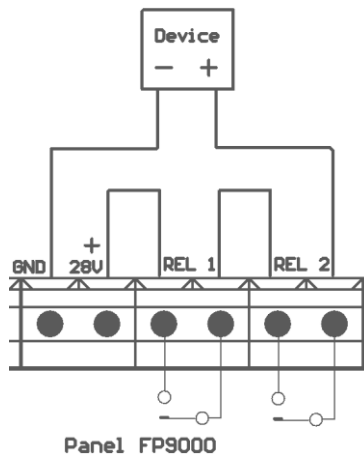

Fig. 8

A necessary condition is that both outputs must be connected separately, the two lines only. (In case of Fire on one line to be activated REL 1 and Fire in the other line - REL 2). Joining the outputs is done by the Lines setting menu.

If relay outputs are not used, then its terminals remain free (nothing is connected to them).

➤ **Outputs - Programming and parameter setting outputs for executive devices.**

Relay outputs: REL Fault and REL FIRE are automatic and not subject to programming, prohibition and delay.

- **Programmable relay outputs** Fire (REL 1) and (REL 2), programmed from menu “Lines setting” (see above "Programming and setting the Fire alarm lines "). They can join any line as well as can be set a delay for each line individual activation. Outputs (REL 1) and (REL 2) **cannot** be prohibited.
- **Controllable programmable outputs** Fire (Out 1) and (Out 2) are programmed from the Line settings menu (see above "Programming and setting the Fire alarm lines"). They can join each line and it can be set a delay for a delay for each line individual. Outputs (Out 1) and (Out 2) **can** be prohibited. When prohibited the supply line for damages is not monitored and the output is not activated.

5.4. Power supply connection

To the terminal with mains fuse connect feeding cable observing the following positions.

- P - power wire " Phase";
- N - power wire " None ";
- "Earth" - safety ground wire.

The cable should be double insulated and section not less than 0,5 mm² for power cables and 1,5 mm² for the safety ground wire.

The other end of the feeding cable is connected to the mains using a junction box.

The mains power supply of the panel should be on a separate circuit.

6. PUTTING THE REPEATER IN WORKING CONDITION

- Check the connection to mains power supply.
- Check the correct connection of peripheral devices.
- Place the fuse in the terminal.
- Join the feeding cables to the batteries, where as the batteries are connected in series. To the positive terminal of the battery join the red wire and the negative – to the blue wire. The overall voltage of both batteries must be greater than 17,6 V, otherwise the panel does not recognize them.
- If everything is done correctly and the lines parameters are within the factory settings, the panel enters Duty Mode.
- Mounted wires to build a network of panels and repeaters.
- Place jumpers shunting the first and last panel in the network. Jumpers on the other panels are removed.
- Menu repeater programmed parameters of all remote panels.
 - On / Off
 - Interface number. Panel interface FP9000L number coincides with the serial number. Panels FP9000 numbers programmed menu of the fire panel.
- Set the accession of exits and the respective delays, if they are necessary.
- If necessary, program and adjustment to other parameters of the repeater and the fire panels from the respective menus. If necessary, adjusts the clock for real-time of the panel.

- Reset archive events.

7. LEVELS OF ACCESS

In repeater FP9000R There are **4 LEVELS** of access to the various indications and control functions.

➤ **Access Level 1**

This level of access is for all persons, whom can be expected to identify and react to Fire alarm or fault. Visible are all light indicators.

Available are the following features:

- suppression of built sounder;
- displaying suppressed messages for Fire, Fault and Disabled components;
- displaying the status of the panels;

➤ **Access Level 2**

This is a level of access to persons, who are responsible for the safety and are trained and authorized to operate the panel in the conditions:

- Security;
- Fire;
- Fault;
- Disabled component;

In access level 2 are available are following features:

- Exit from Fire condition;
- suppression of the outputs, activated when Fire;
- involuntary activation of the controllable outputs;
- suppression of built- in sounder.

Switching from **Level 2 to Level 1 and vice versa** happens after a combination of buttons and the relevant information on the display.

The selection happens from the second menu of the main menu - " Access Level ".

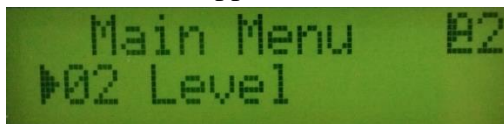

After entering the menu, with button «Enter» and the corresponding buttons up and down choose the level. Confirm again with «Enter».

The selected level, in Security/Duty mode, is displayed in the upper right corner of the display.

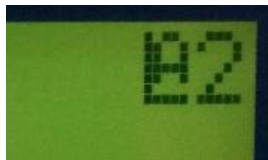

➤ **Access level 3**

In Level 3 is reached by entering a password and opening the front cover of the panel.

Available are the following panel's features:

- all possibilities from Levels 1 and 2
- Replacing a burnt fuse;

➤ **Access Level 4**

This is the level of access for persons who are trained and authorized by the manufacturer to repair the panel and modify the software.

Special means are required to enter this level.

8. CONDITIONS OF PANEL



FP9000R panel operates in four conditions: Duty, Fire, Fault and Disabled component.

8.1. DUTY CONDITION

In Security condition, the panel is ready for indication and treatment of Fire and Fault conditions in case of relevant events.

- **LED indication** – light up the indicator: "POWER" and "DEL OUTS" at preset delay of connected output.
- **Beeper indication** - off.
- **Text message indication** - displayed labeled " Security " and information about the current time.
- **Active buttons** - button . When you press it the panel enters Information and Control condition.

8.2. FIRE CONDITION

- The panel may be in Fire condition in one or several remote fire panels.
 - **LED indication** - light indicators:
 - "FIRE"
 - "1 2 3 4 5 6 7 8" Local indicator(s) for Fire panel.
 - **Beeper indication** - Sounder is constantly on.
 - **Text messages** - Text information about the lines in Fire are displayed on the display:
 - **Active buttons**
 - button "**BUZZER SILENCE**". Pressing it leads to:
 - **Disabling** the embedded sounder, if it has responded to Fire or Fault;
 - **Activating** the built-in sounder, if the panel is in Fire or Fault condition and the tone is disabled by previous pressing of the same button.
 - button "**SOUND SILENCE**". Press it to :
 - When suppressed outputs for Fire - forced activation of the outputs;
 - When activated outputs for Fire - suppression of these outputs.
 - button "**RESET**". Press it to :
 - the panel is forced to exit Fire condition and reset fire panels.
 - buttons  and . Pressing them leads to:
 - Displaying suppressed messages display lines in Fire.
 - buttons . Press it to :
 - Entering in Information and Management condition.

8.3. Fault Condition

Repeater panel enters Fault condition when registering any of the following events:

- Fatal system fault;
- Low power - diluted battery during dropping in the mains supply;
- Fault in a remote fire panels;

- Fault in a controllable output - short circuit or break;
- Damage to the mains;
- Fault in backup batteries;
- Short circuit or leakage to ground wire;
- Fault in power lines;
- Fault in power supply for external devices;
- Fault in network or transmission device.

When systemic failure processor can not continue.

Exit for this kind of fault can only be accomplished by turning off the power and subsequent repair.

All damage, except for the system kind, lead to switching off some periphery.

Exiting this condition happens automatically to 100 seconds after dropping out (removal) of the fault.

When in fault "Low power" the built-in sounder is activated with discontinuous signal.

- **LED indication** – lights up the indicator : "FAULT" and depending on the fault :
 - Upon System error - indicator "SYS FAULT" lights up in continuous yellow light;
 - Upon fault in Fire alarm line - individual fault indicator flashes yellow light respectively when:
 - short circuit - with a frequency of 1 Hz (slow flashing);
 - interruption - a frequency of 4 Hz (fast flashing);
 - removed Fire alarm detector - a frequency of 4 Hz, every one second (choppy rapidly flashing).
 - Upon fault in a controllable output - indicator "OUTS" lights up with flashing yellow light;
 - Upon fault in mains supply - indicator "POWER FAULT" lights up in continuous yellow light;
 - Fault in the local network or the transmission device - indicator "COMUN" lights up with a steady yellow light.
 - If the sound signal is suppressed by button "BUZZER SILENCE", LED indicator lights up a constant red light.
- **Beeper indication** – The built-in sounder is activated with a discontinuous signal.
- **Text messages indication** - Text messages for fault condition are displayed by priority on the main display screen.

If we have more than one failure, by button  and regulating buttons enter the menu "FAULT". In this menu you can see all registered damage.

- **Active buttons**
 - button "BUZZER SILENCE". Pressing it leads to:
 - **disabling** the embedded sounder, if it is activated by Fire or Fault;
 - **activating** the built- in sounder, if the panel is in Fire or Fault condition and the annunciator is disabled by previous pressing the same button.
 - button . When you press it, the panel enters Information and Control condition.

8.4. DISABLED COMPONENT CONDITION



After selecting the relevant line and/or controllable output with buttons, switch the conditions "on" and "off", respectively for disabled function on and off.

The disabled controllable output is switched off (the executive device can not be activated) and is not monitored for failure.

- **LED indication** - light indicators:
 - "DISABLE" lights up with a constant yellow light
 - "OUTS" flashes when a disabled controllable output.
- **Beeper indication** - not affected by the disabled component condition.
- **Text messages indication** - Information about the lines and controllable outputs in Disabled, are displayed on the display. When "on" we have a disabled component in "off" active.
- **Active buttons**
 - buttons . Press it to :
 - Enter Information and Management condition.

8.5.1. TEST LED

Testing of LED indication the panel done by menu «Test indication».

With button  activate the illumination of all LEDs. The exception is the indicator for systemic failure that should not be on. With button  start the test. If button  is not pressed, the panel automatically enters Duty condition after 30 seconds.

8.6. INFORMATION AND CONTROL CONDITION

The panel has a display and keyboard to check the parameters, settings, monitoring and changing conditions, displaying archives of events and etc. From the menus can be selected more than 100 active screens for setup and management of the panel.

By menus you can perform the following actions:

Main menu: /access level 1 or 2/

- View all the remote fire panels in Fire;
- View all the failures;
- Change the access level from 1 to 2 and vice versa;
- Review and launch (at access level 2) of the Disable condition;
- Review and launch (at access level 2) of the Test in line condition;
- Review of current current in the Fire alarm lines.

System features: /Access Level 2/

- Test indication;
- Setup the real-time clock, year, month, day, hour, minute, second, correction;
- Check on the Fire counter;
- View the archive of events; /up to 1200 events/

Setting: /Access level 2 + password/

- Setup the parameters of the repeater : Language, Network address and on / off function to check for ground wire failure;
- Remote fire panels Setting.
- Input factory settings menu;
- Change the password to access the setup menu;
- Delete archive.

! When working with menus to have the following characteristics.

- When working with menus, use the four active buttons for information and management. (see Controls for management and indication).
- If you enter into the menu, its structure and has no activity for more than 30 seconds, it automatically returns to Duty mode.
- If you can not enter into a menu, check whether the access level is set properly.
- Please note that Setting Mode stops processing the Fire alarm lines.
- After exiting from the Setup menu the panel goes through reset and record the new set parameters.

9. CONDITIONS FOR USE, STORAGE AND TRANSPORT

➤ **Operation and storage**

The panel is used and stored in closed rooms under the following conditions :

➤ **Temperature**

- storage from 5°C to 35°C
- transport from -10°C to 50°C
- working from -5°C to 40°C

➤ **Relative humidity**

- storage to 80%
- working to 93%

➤ **Transport**

The panel is transported in covered vehicles, in factory packing and in the above atmospheric conditions.

10. DELIVERY COMPOSITION AND COMPLEXITY/SET

• Fire Panel FP 9000R	1 qty.
• Fuse 6,3A;	1 qty.
• Fuse 4,0A;	1 qty.
• Connective bridge for batteries;	1 qty.
• Packaging.	1 qty.

11. WARRANTY

The manufacturer guarantees the product's conformity with EN 54-2: 1997, A1: 2006, EN54-4: 1997, A1: 2002, A2: 2006. The warranty period is 36 months from the date of sale, provided that:

- the conditions of storage and transport were met;
- the startup has been done by authorized persons;
- The requirements for operation conditioned in this instruction were met;
- Defects are not caused by natural phenomena and accidents of the plug socket.

DMTeh wishes you splendid work!

For any questions may contact the company's technical staff DMTEch, by email.

e-mail : office@dm-teh.com